

modulotecnico

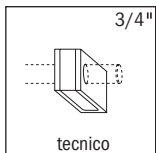

Tecnico bracket is available
in single or double format

ROBERT ALLEN

PRESENTS

B L ● M E

3/4"

available rod diameter

modulotecnico

measurements

finial / holdback

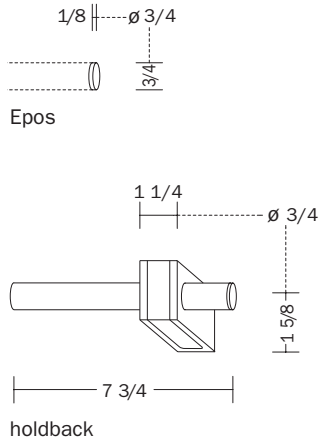

brackets

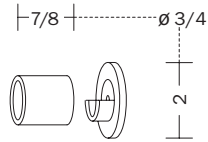

inside mount bracket

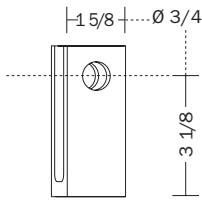

bracket

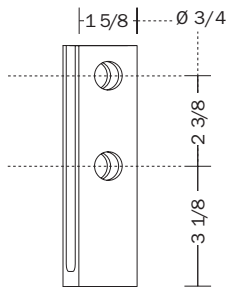

double bracket

accessories

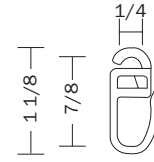

pleating hook

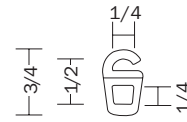

eyelet hook

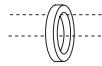

standard ring

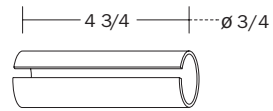

tube connector